

TOP WHORL LARGE and TOP WHORL SMALL

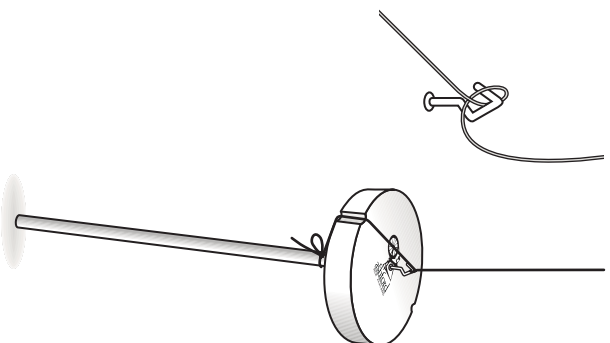

1 Tie a leader (a piece of yarn 1m/40") to the shaft under the whorl, wrap it around the shaft & under the hook.

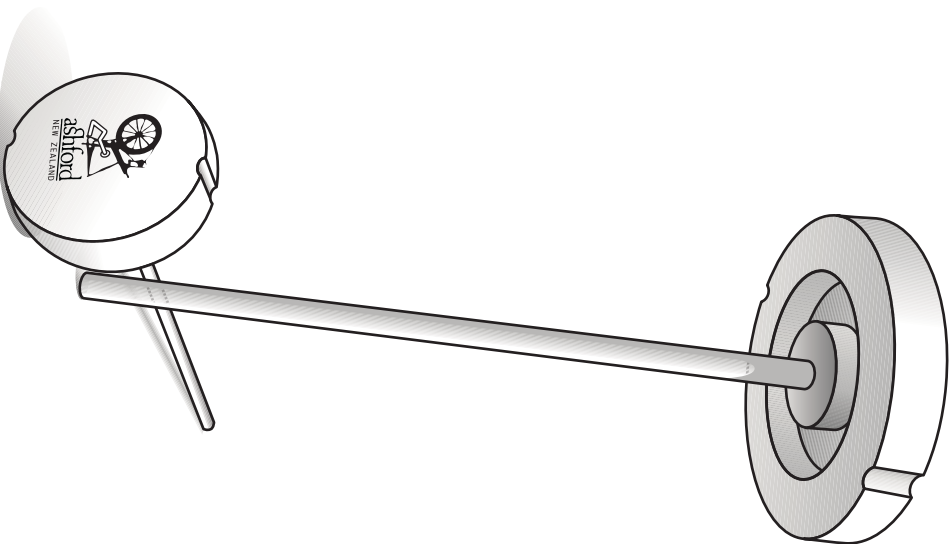
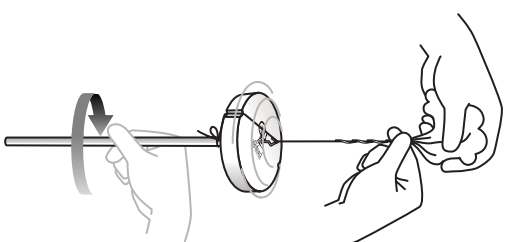

2 Spin the spindle clockwise & allow the leader to join onto your prepared fibres.

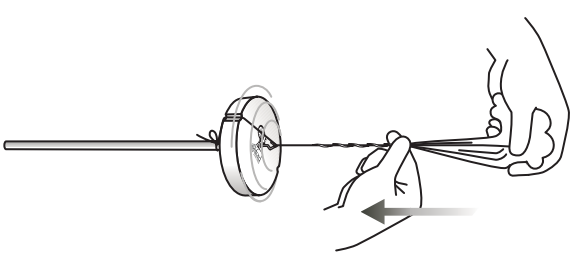

3 While keeping the leader pinched with one hand, draft the fibres down.

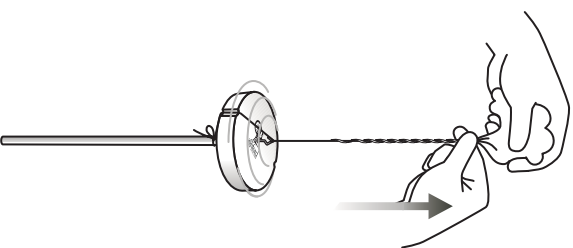

4 Slowly slide your fingers back up the drafted fibres allowing the twist to follow. Once twisted, the yarn will support the weight of the spindle.

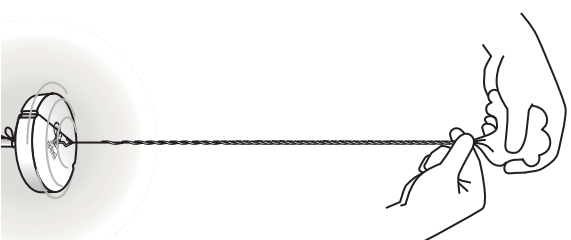

5 Keep the spindle spinning while drafting more yarn until the spindle reaches the floor.

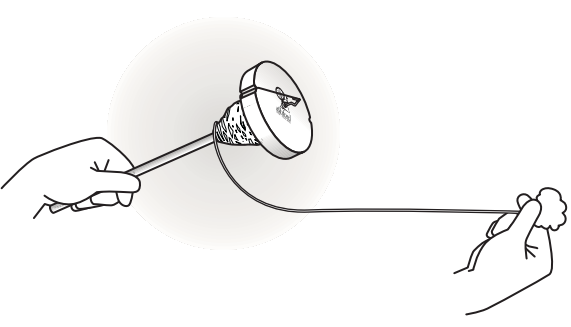

6 Wind the yarn around the shaft to form a cone & then repeat the process. Slide the cone off the shaft & use either as a single or ply 2 together with the spindle spinning anti-clockwise.

Ashford Handicrafts Ltd.

P O Box 474, Ashburton, New Zealand

Telephone: 64 3 308 9087 Facsimile: 64 3 308 8664

Email: sales@ashford.co.nz Internet: www.ashford.co.nz